

NATIONAL RADIO NEWS



DEC.-JAN.
1944-1945

IN THIS ISSUE
Tube Substitutions
Oscillations, Squeals and Motorboating
Alumni Association News

VOL. II
NO. 6



This Christmas Season, we direct our Greetings to the N. R. I. Students, Graduates, and Employees who are now serving in the Armed Forces of the United Nations.

To each and every one of you, our Christmas Wish is: Strength and success in your undertakings—and a safe return to your home.

The deeds *you* have done and will do. . . .

The great personal sacrifices *you* have made and will make. . . .

The service *you* are rendering to our Country, to our people, and to all humanity. . . .

. . . .will make it so that at some future, happier Christmastime, all people of the world can again sing
PEACE ON EARTH, GOOD WILL TOWARD MEN.

J. E. SMITH, President

E. R. HAAS, Vice President



Tube Substitutions

By WILLARD R. MOODY

N.R.I. Consultant



Willard R. Moody

WHEN tube shortages develop, there is no alternative but to substitute an equivalent type tube. In some cases, this will mean that an adapter or a new socket must be installed. In other cases, the filament circuit may need to be modified, or both of the above changes may be required—as dictated by the circumstances.

The tube line-up of a typical receiver is shown in Fig. 1. All or any one of the tubes indicated may be scarce and replaceable only with some form of substitute type. Let us consider the replacement of the tubes in the following order: 12SQ7, 12SA7, 12SK7, 50L6, 35Z5GT.

Replacing the 12SQ7. As a first step in considering the replacement of this tube, we study its pin connections and general characteristics by reference to a tube chart or tube manual. Note that the tube is a duplex diode-triode type and

tube if you can get it. However, a tube having a mu of 70 or 100 would be better. In looking through the tube manual, seeking a substitute, we would look for a tube type, not merely a

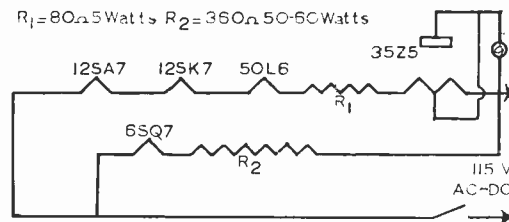

Fig. 2. The modified circuit of the receiver in Fig. 1, showing the changes necessary to use the 6SQ7.

$R_1=80$ ohms 5 watts
 $R_2=360$ ohms 50-60 watts

tube number, and then would check its characteristics against the original.

The 12SQ7GT could be substituted directly, with no circuit or socket changes. A tube shield, to prevent hum and oscillation, might be required, and the shield could be grounded to the chassis with a piece of flexible braid, or grounded in any other practical manner.

The 6SQ7 or 6SQ7GT tubes could be substituted for the 12SQ7, provided a proper change in the filament circuit is made. One way in which this change can be made is shown in Fig. 2. The



Fig. 1. The filament circuit of a typical a.c.-d.c. receiver.

that the triode has an amplification factor of 100. The 12SR7 has an amplification factor of 16 and will work at a slight loss in gain. Use this

current in the series circuit using R1 is .15 ampere and in R2 it is .3 ampere.

If a type 14B6 tube is used, the filament circuit need not be changed. The pin connections of this tube, however, are different than those of the 12SQ7, as shown by Fig. 3. These and other socket drawings to follow are for an "under-chassis view," looking at the wiring in the radio.

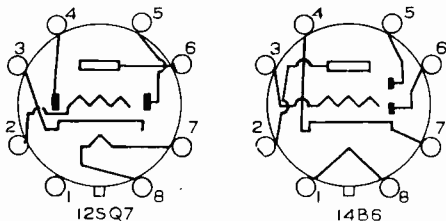

Fig. 3. Comparison of the 12SQ7 and 14B6 socket connections.

Note that the 14B6 has two cathode connections. Only one of them need be used, whichever one is convenient. The electrical characteristics of the two tubes are practically identical. Revision of the socket wiring and replacement of the original 8 prong octal socket with an 8 prong loktal socket is all that is required.

If the 7B6 is used, a loktal socket will be needed. In addition, the filament circuit revision of Fig. 2 would be required, for the 6SQ7 filament rating is equivalent to the 7B6 filament rating.

The 12Q7GT is about the same physical size as the 12SQ7, but has a glass bulb and a top cap connection for the triode grid. It may be necessary to shield the tube, and to shield the grid wire, if the 12Q7GT is substituted for the 12SQ7.

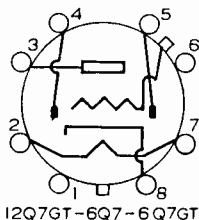

Fig. 4. The pin connections are shown above. The 12Q7GT, 6Q7, and 6Q7GT may be used to replace the 12SQ7.

The socket need not be changed but the wiring must. The pin connections of the 12Q7GT are shown in Fig. 4.

Page Four

If the 6Q7 is used, no tube shield is necessary but the grid wire must be shielded. The 6Q7GT, having a glass bulb, requires a tube shield. A filament circuit revision, as for the 6SQ7, illustrated in Fig. 2, is necessary.

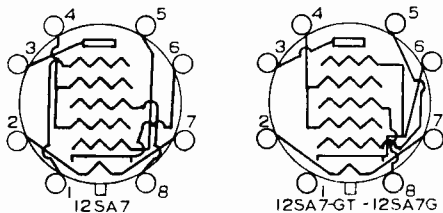

Fig. 5. The suppressor grid of the 12SA7 connects to pin No. 1, but goes directly to the cathode and pin No. 6 in the 12SA7GT and 12SA7G.

The 7C6 would require a new loktal socket. Its pin connections are the same as the 7B6 and 14B6. A resistor having a value of 40 ohms and 2 watts would be hooked in series with the 7C6 filament, and that is all the filament circuit change would involve.

Replacing the 12SA7. This tube is a pentagrid converter. The prefix penta means 5 and such tubes have 5 grids. The 12SA7 suppressor grid connects to pin terminal one. If the 12SA7GT is plugged in the 12SA7 socket the connections will be correct. If the 12SA7 is plugged in the 12SA7GT socket, the suppressor grid pin connection must be connected to B minus or ground. The cathode connection will go to a tap on the

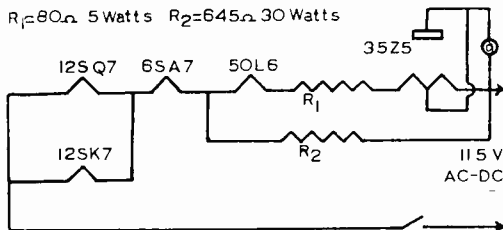

Fig. 6. Circuit revision when replacing 12SA7 with 6SA7.

$R_1 = 80 \text{ ohms } 5 \text{ watts}$
 $R_2 = 645 \text{ ohms } 30 \text{ watts}$

oscillator coil. The 12SA7GT replacement of the 12SA7 requires no circuit change. The pin connections of the 6SA7 are identical with those of

the 12SA7 and the 6SA7GT and 12SA7GT are alike in their pin connections.

When the 6SA7 or 6SA7GT are substituted for the 12SA7, the filament circuit must be modified. The circuit of Fig. 6 shows one way in which the job may be done.

If a type 14Q7 is used, a new loktal socket will be required. The pin connections of this tube (same as for 7Q7) are shown in Fig. 7. Note that the suppressor grid connects to pin terminal No. 5. This terminal should be connected to B minus or chassis ground if the ground is at B

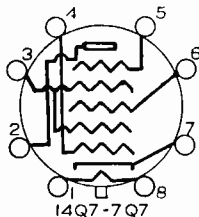

Fig. 7. The 14Q7 or 7Q7 may be used as substitutes for the 12SA7.

minus potential. The 7Q7 has the same pin connections, but its heater draws .3 ampere. The filament circuit may be modified as shown in Fig. 8. (Don't confuse the 7Q7 and 14Q7 which are converters with the 6Q7 and 12Q7 which are duplex diode-triodes.)

A study of the pin connections and structure of the 12A8GT and 6A8GT tubes will show these tubes do not have suppressor grids but do have anode grids. By simply connecting the anode grid to the screen, the 12A8GT may be made practically equivalent to the 12SA7GT or 6SA7GT, and fairly good results can be obtained. The pin connections of the 12A8GT and 6A8GT are shown in Fig. 9. The 12A8GT will not require a filament circuit change. The 6A8GT will require a change for a .3 ampere tube. The heater circuit arrangement of Fig. 6 may be used. Simply substitute in the drawing the 6A8GT heater for the 6SA7 heater.

If there is sufficient chassis space, the 12A8G may be used. It is about the same size as the 6A8G with which you are probably familiar. The 6A8 metal can be used as a substitute for the 12SA7 if the 6A8 is available, and if the filament circuit is rearranged.

Replacement of the 12SK7. The 12SK7 is an r.f. or i.f. amplifier. It may be replaced directly

with a 12SK7GT. If the set oscillates or howls when this is done, it may be necessary to shield the tube and to ground the shield to the chassis. The 12K7GT can also be used. This tube will require a tube shield, a longer grid lead than the 12SK7GT, and a top cap connector. The pin connections are shown in Fig. 10. The 12SK7GT

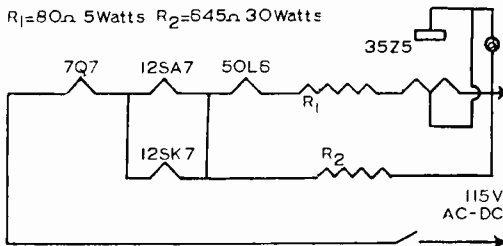

Fig. 8. The changes required to use the 7Q7 in place of the 12SQ7 are shown by the above diagram.

$R_1=80$ ohms 5 watts
 $R_2=645$ ohms 30 watts

and 12K7GT require no receiver filament circuit changes if substituted for the 12SK7. Realignment, however, may be necessary for best results.

The 6SK7, 6SK7GT and 6K7GT would require changes in the filament circuit. The 7A7 is a substitute for the 12SK7 but requires a filament circuit change, as it draws .3 ampere. The 7B7 draws .15 ampere at 6 volts on the filament and may be substituted for the 12SK7 provided a resistor of 40 ohms rated at 5 watts is used in series with the 7B7 filament.

Replacing the 50L6. The 50L6 may be replaced with a 50L6GT. A 50L6G can be used provided

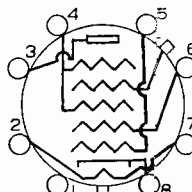

12A8G-12A8GT-6A8GT-6A8

Fig. 9. By tying together pin terminals 6 and 4, the 12A8-GT and 6A8GT tubes may be made to serve as replacements for the 12SA7.

there is sufficient room on the chassis and in the cabinet. No circuit changes are required. If the 35L6GT or 35L6 is used, a resistor must be con-

nected in series with the 35L6GT filament. The 50L6GT requires 50 volts at .15 ampere. The 35L6GT is rated at 35 volts and .15 ampere. The voltage to be dropped in the resistor is $50 - 35 = 15$ volts. Dividing 15 by .15 you obtain 100 ohms.

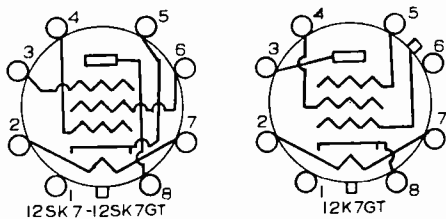

Fig. 10. The pin connections of the 12SK7-12SK7GT compared with the 12K7GT.

The power rating is $E \times I = .15 \times .15 = 2.25$ watts. Then, $2 \times 2.25 = 4.5$. A 5 watt resistor would be suitable (2 is a safety factor, and a conservative rating, to prevent overheating and burnout of the resistor, is adopted).

The 25L6GT could be used as a 50L6GT substitute, provided the filament circuit is changed for a .3 ampere tube. This is shown in Fig. 11.

The 35A5 is a loktal type tube. To substitute this tube for the 50L6GT, install a loktal socket in place of the 50L6GT octal socket. It also will be necessary to add in series with the 35A5 filament circuit a 100 ohm 5 watt resistor.

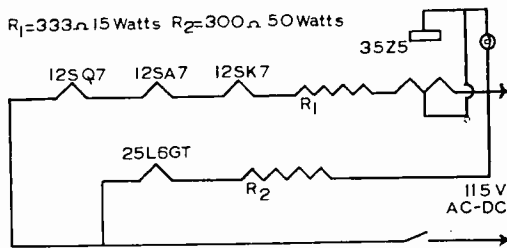

Fig. 11.

$R_1 = 333$ ohms 15 watts
 $R_2 = 300$ ohms 50 watts

Substitution of the 25L6, 25L6GT or 25L6G for the 50L6, 50L6GT, 50L6G, 35L6, 35L6GT or 35L6G.

The 50A5 may also be used. This tube requires a loktal socket. Its plate load resistance is 3000 ohms. The 50L6GT has a load of 2000 ohms.

For best results a new output transformer to match the speaker voice coil to the plate circuit is required, but in most cases the impedance mismatch will not be extremely serious and fairly good results can be secured. The filament voltage and current of the 50A5 is the same as for the 50L6.

The 70A7GT has a 70 volt .15 ampere filament. The circuit modification that may be made is shown in Fig. 12.

The 70A7GT is a good substitute for the 50L6. The 117 volt filament beam power tubes have low power output and load resistances that are quite

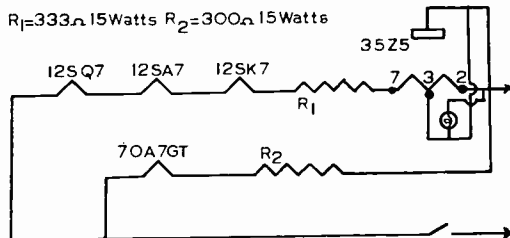

Fig. 12.

$R_1 = 333$ ohms 15 watts
 $R_2 = 300$ ohms 15 watts

Using the 70A7GT as a replacement for the 50L6GT, 35L6GT, etc.

different from that of the 50L6GT, so that the 117 volt series of tubes are not satisfactory substitutes.

The 35Z5GT and Other Rectifiers. The 35Z5GT may be replaced with the 35Z5G, 25Z6G, 25Z5.

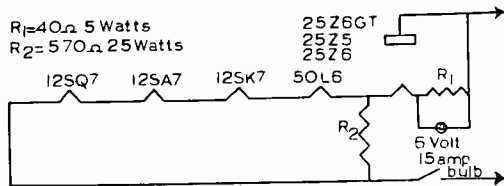

Fig. 13.

$R_1 = 40$ ohms 5 watts
 $R_2 = 570$ ohms 25 watts

Replacing the 35Z5GT with a 25Z6GT, 25Z6, 25Z5.

25Z6, 25Z6GT, 117Z6GT, 35Y4, 35Z3, 35Z4GT, 45Z5GT, 50Z6. If space permits, a type 12Z3 may also be used. When the original and replacement

tube filament ratings differ, circuit changes are necessary.

The 35Z5GT is a special rectifier tube. It has a tapped filament. A pilot lamp is usually connected between pins 2 and 3, as shown schematically in Fig. 12. Should the section of the filament between pins 2 and 3 burn out, a 40 ohms,

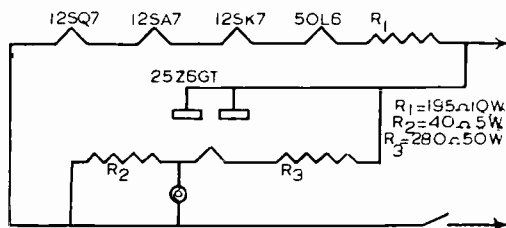

Fig. 14.

R1=195 ohms 10 watts
 R2= 40 ohms 5 watts
 R3=280 ohms 50 watts
 (use line cord type resistor)

Replacement of the 35Z5GT using a 25-volt, .3-amp. filament rectifier (25Z5, 25Z6, 25Z6GT).

5 watt resistor may be shunted across terminals 2 and 3 at the socket and the tube may be continued in service providing it is otherwise all right.

The 25Z5 has a relatively large glass bulb envelope. It may not fit in some midget sets. Its

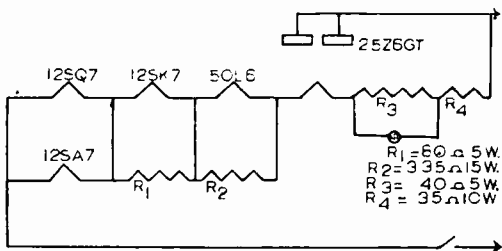

Fig. 15.

R1= 80 ohms 5 watts
 R2=335 ohms 15 watts
 R3= 40 ohms 5 watts
 R4= 35 ohms 10 watts

Replacement of the 35Z5GT using a 25Z5, 25Z6 or 25Z6GT.

filament requires .3 ampere. If this tube is substituted for a 35Z5, a filament circuit change will be required.

The 25Z6 and 25Z6GT also requires .3 ampere. The filament circuit change required is shown in Fig. 13. The filament circuit may be altered in other ways. Typical circuits are shown in Fig. 14 and 15.

The 35Y4 has a .15 ampere heater and no change in the circuit is required as this tube also has a tapped filament. The socket connections, however, are different. A loktal socket is necessary. If a rectifier of the .15 ampere type is used (35Z3 for example), without a filament tap, the circuit of Fig. 16 may be used. The type 35Z3 can be used in Fig. 16. The voltage drop across the pilot lamp in series with the plate circuit is negligible and will have no effect on the radio

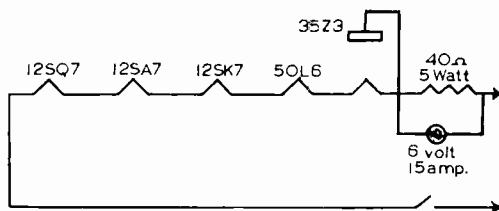

Fig. 16. The 35Z3 as a replacement for the 35Z5GT is used in this circuit.

operation. A shunt resistor of 40 ohms and 5 watts may be used.

If the 117Z4GT is substituted for the 35Z5, the circuit of Fig. 17 may be used. A 2 volt, .06 ampere bulb is necessary. A shunt resistor is placed across the lamp to prevent burning out the bulb when the set is first turned on. The reason is that the lamp resistance is low when the filament is cold and a current surge into the

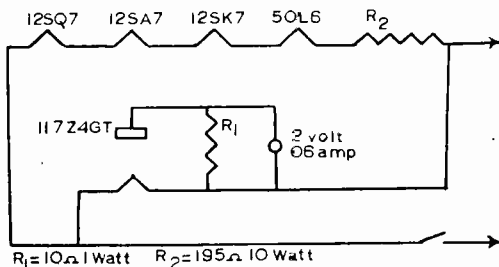

Fig. 17.

R1= 10 ohms 1 watt
 R2=195 ohms 10 watts

Replacement of the 35Z5GT with a 117Z4GT is illustrated in this circuit diagram.

low resistance might burn it out were it not for the protection afforded by the shunt resistance which keeps the voltage across the lamp terminals at a reasonable value.

Replacing the 5Y4G. In many Philco receivers the 5Y4G is used in a rectifier socket which is mounted on top of the power transformer. The shell of the transformer can be taken off and the connections changed at the rectifier socket. A 5Y3G may then be substituted. A 5Z4 can also be used if available.

The reverse changes may also be made. When the 5Y4G is available in place of the 5Y3G or 5Z4, it can be substituted.

The 80 rectifier socket, if it can be installed, may be used to take an 80 tube which will replace any of the above types.

Replacing the 50Y6. The type 25Z5 may be used as a substitute for the 50Y6. A 25Z6, 25Z6GT, 12Z5, 25Y5, 25Z6MG and 50Z6 could also be used.

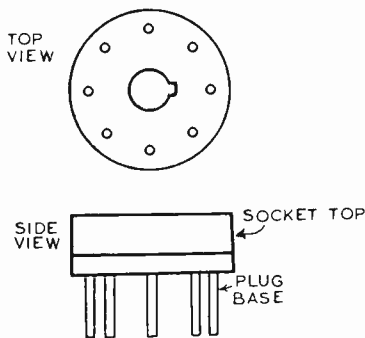

Fig. 18. View of a typical adapter.

The same holds true for the 25Z5, 25Z6MG and other 25 volt types. The 50Z6G, on the other hand, has a 50 volt, .3 ampere heater and a lowering of the filament circuit resistance will be required.

Circuit Modifications. Remember that a circuit change should only be made when it is absolutely necessary. In making the change, study the problem carefully and then work out a solution. Refer to a tube manual or a tube chart so that you can determine the filament current and voltage required for a particular tube type as well as other requirements of the tube in normal operation. As an example, output tubes require definite values of load impedance or load resistance. If an improper value is used, distortion and impedance mismatching may result.

An adapter permits the installation of a substitute tube without circuit changes and consists of a socket and plug, as shown in Fig. 18. The socket contacts in the top are connected by wires to the pins in the plug base. These wires are concealed within the adapter. In some cases it is practical to use a small resistor inside the adapter but in general this is not good practice because there is little ventilation and the resistor may get too hot and burn itself out. A flexible wire wound resistor is used and is curled up inside the adapter.

Before the war, adapters could be obtained without much trouble. The material for them now is scarce but it is possible to make adapters which will serve in tube substitution work. Some radio distributors have adapters for sale. Old tube sockets may be used for the tops and bases taken from defective tubes may be used for the plug-in part of the assembly. (Assuming the defective tubes have not been damaged so badly that the bases are broken or otherwise made unserviceable.)

Adapters are convenient in many cases, as they do not call for any change in the wiring of the set itself and when the original tube becomes available, as possibly it may in the future, going back to the original tube is merely a matter of removing the adapter and plugging in the tube. If the original type of tube is not available, the substitute is plugged into the top of the adapter and the adapter plug base goes into the receiver's tube socket.

The adapter has important disadvantages. It lengthens the leads to the tube and results in detuning circuits, so that realignment is often required in an r.f. circuit when a tube in such a circuit is replaced. Audio circuits are not critical with respect to tuning, but in some cases the stray coupling between leads may cause audio oscillation or result in hum pickup if adapters are used. Adequate insulation of wires is particularly necessary in adapters used in rectifier tube circuits. When an adapter is used for a tube in an r.f. circuit, shielding may be a problem. The shield must be grounded to the chassis. Because the shield is aluminum, soldering to it is not practical. It is possible to ground the shield effectively by cutting a small piece of tin and bending it properly as shown in Fig. 19. First, the metal strip is cut from an old piece of tin. Be very careful in working with the material as it is an easy matter to get a nasty cut should the tools or tin slip while you are doing the work. The strip is next drilled. It will usually be easier to do this without making a mess of the job if the metal strip is placed between two pieces of wood in a vise and then a small hand drill is used. If you attempt to punch the tin with a

hammer and punch or nail set, you will find it somewhat difficult to get a clean hole. The tin should be tightly clamped in the vise, between the wood blocks.

The metal strip is slipped over a tube prong which is at chassis or ground potential, such as a cathode pin or suppressor grid connection. Some tubes, the 6A8G for example, have provision for grounding by means of a base pin, usually pin No. 1.

If the adapter makes the tube stick up too far from the chassis, you may not be able to use the substitute tube, because it will not fit inside the

scarce tube types, adapters cannot be used because they take up too much room.

In making up an adapter, first consider the circuit changes that will be necessary. If they are very expensive, it will not be possible merely to install the new tube with an adapter. Using an adapter will mean that you won't have to remove the original socket from the radio. In some sets which have complicated wiring, this is a real advantage. In others, where the wiring is not very difficult to handle, drilling out the old socket and installing a new one is the simplest, easiest and best way to do the job.

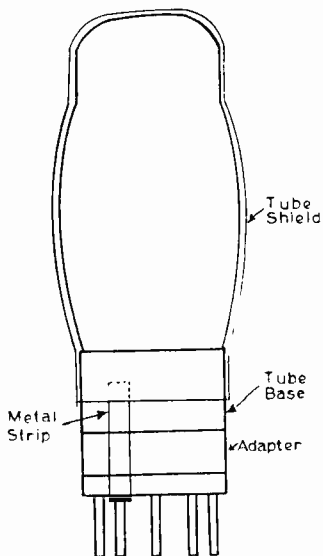
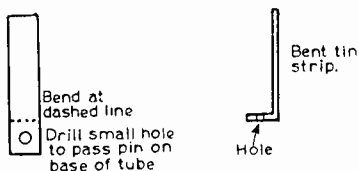

Fig. 19. Details of tube shielding and adapter construction.

radio cabinet. Give careful thought to the size of the replacement tube, as well as to its electrical characteristics. Often a 6A8GT may be used as a replacement, for example, where the larger 6A8G would not fit into the radio. In many midget sets which use the 12SA7 and other



When You Write to N.R.I. for a Diagram

When requesting service data on a receiver which you have for repair, always give the NAME of the set, the MODEL NUMBER, and the kind and number of the tubes used in the receiver. **WITHOUT THIS INFORMATION WE CANNOT SEND YOU A DIAGRAM.**

Manufacturers invariably put out their service information by model numbers. The serial number is, generally, very little help in identifying the set.

They rarely fail to put the model number of a receiver somewhere either on the chassis or the cabinet. Go over the inside of the cabinet for this number. In some cases the model number is stamped on the front of the chassis (not on the cabinet), and it is necessary to take the chassis out of the cabinet to find the number. Some sets have a wiring diagram as well as the model number pasted on the **BOTTOM** of the cabinet.





Two views taken at the 30th Anniversary Luncheon of the National Radio Institute, held at the Statler Hotel in Washington, D. C., on October 18, 1944.

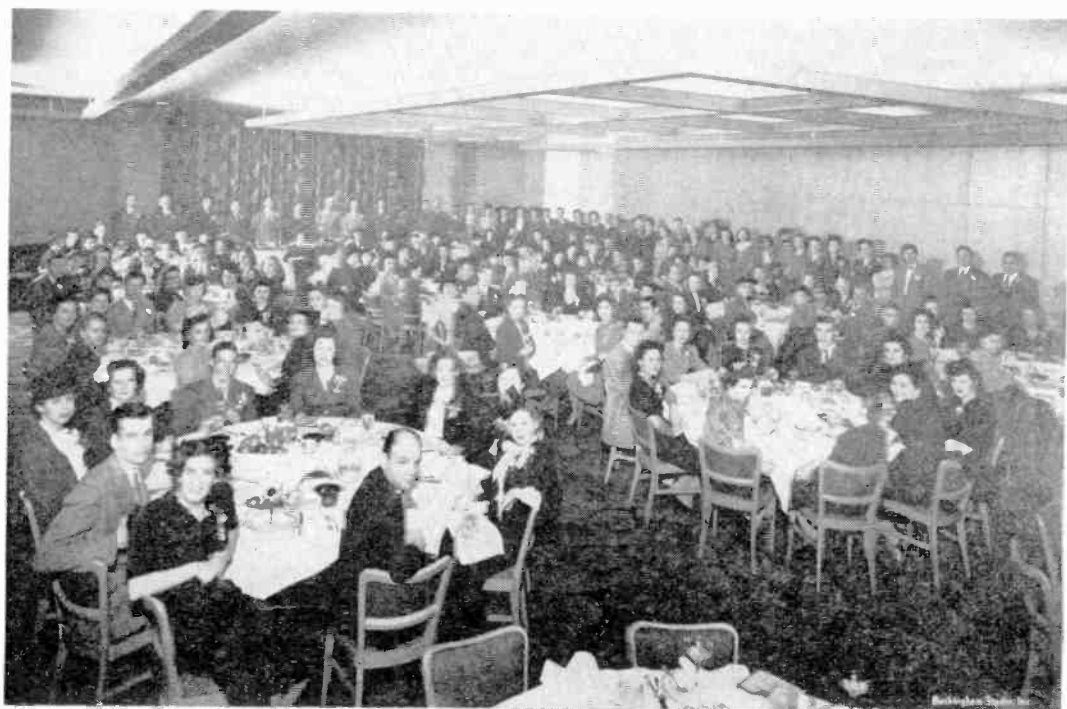

30th Anniversary Luncheon of the National Radio Institute

By Joseph Cunningham, Chairman, Publicity Committee



Jos. Cunningham

On October 18 the National Radio Institute celebrated its 30th Anniversary with a luncheon for the employees. It was held in the Federal Room of the Statler Hotel in Washington, and provided an enjoyable afternoon for everyone.

Although the ever present spirit of the war kept the affair relatively simple, the employees arranging the details did an outstanding job. These committees were headed by Mr. S. M. Armstrong, Advertising Manager, and Mr. Gordon Birrel, Office Manager, with Mr. Armstrong acting as chairman. The effect of the floral arrangements, corsages and boutonnières can be seen in the pictures on the opposite page. The combined efforts of responsible groups brought universal acclaim from other employees.

The photographs were taken just before the luncheon. The fact that N.R.I. filled the room almost to overflowing made the photographer's task quite difficult but he managed to include everyone. The food was excellent. Music was furnished by Sidney's Mayflower Lounge Orchestra, and before long everyone was singing old favorites to their accompaniment.

Matters took a more serious turn, however, when Mr. Meune, Graduate Service Director, who acted as Master of Ceremonies called upon Mr. Dowie who presented both Mr. Smith and Mr. Haas with engraved gold pen and pencil sets, gifts from the employees to commemorate the occasion and show our appreciation for the leadership that made this 30th Anniversary possible.

Mr. Smith expressed his thanks for the gift, and took the opportunity to trace many of the highlights in the growth of the Institute. Even some of the employees of more than 20 years service, honored with seats at the speakers' table, had forgotten many of the incidents recalled by Mr. Smith. The days when the school was a resident class of only four students taught by Mr. Smith, the development of the correspondence Course, the gradual increase in size, the dark days of the early 30's and the plans for the future, were covered. Everyone felt a part of Mr. Smith's pride in the fact that the Institute has been in existence during two wars, and has contributed greatly toward Victory in both.

Mr. Haas followed his fellow founder with a tribute to Mr. Smith's abilities and an interest-

ing talk on the past and future of the Institute. In needless consideration for his listeners, he cut his speech from a proposed one minute for each past year to one-quarter of a minute, thus depriving everyone of many entertaining reminiscences.

An interesting point was raised during these talks when Mr. Smith had members of various years of service stand up for recognition. The percentage of employees who have spent many years in the Institute's service was surprisingly high. Attention was also called to the 26 employees now in the Armed Forces who were represented by Capt. George Rohrich of the technical department, now attached to the U. S. Signal Corps; and Miss Jule Shelton, our receptionist for several years, now a Pharmacists Mate 2/c in the Waves.

This serious vein was broken by the entertainment feature of the afternoon—Brandywine and his ventriloquist partner, Joe King. The little dummy, resplendent in his military uniform, took occasion to place a few subtle digs at various members of the staff, to their deep chagrin and the amusement of others. There is still considerable speculation as to the person who supplied Brandywine with those "inside stories."

The affair was brought to a close as Mr. Smith and Mr. Haas made personal presentation of fountain pens and compacts to every employee as another mark of their appreciation for the efforts of each individual. Mr. Smith emphasized that each member of the Institute contributes to the success of the school, and this presentation of gifts was in recognition of this fact.

Everyone agreed that the luncheon was a huge success and the only note of sorrow was that it seemed to end too soon. We're already talking about the 50th Anniversary, but there's some doubt about finding a place big enough to hold everyone if N.R.I. grows as much in the next 20 years as it has in the last.

Of one thing we are sure, though—the 30th Anniversary is just another milestone. There'll be many more to come!

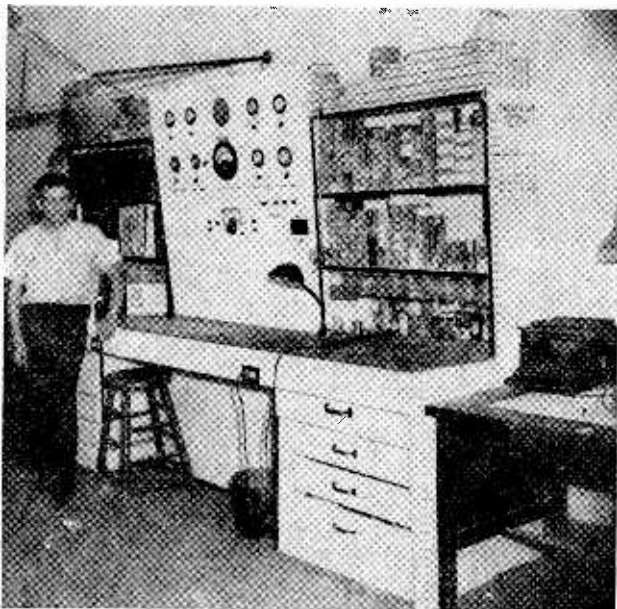

Mr. Brown in his modern servicing shop. Instruments for signal tracing and complete electrical and Radio tests are provided on the test panel shown prominently in the picture. Note the neat, efficient layout used for securing the best possible servicing conditions.

L. Lyman Brown,

N.R.I. Graduate

**Successful Owner of Radio
Servicing Business,
Citizen Extraordinary**

MR. L. Lyman Brown, who owns and operates the Forest Park Radio Co., Springfield, Mass., is the sort of man you would like to meet and know. With over twenty years of experience in the radio business, he has never found a radio which he could not repair, and, as a matter of fact, at least a dozen sets a week, Mr. Brown reports, are brought into his shop by servicemen who are "stuck." Quite naturally, Mr. Brown is proud of that ability to do the tough jobs, to succeed where less well trained and less experienced men fail. And he gives credit to N.R.I. for his training, for enabling him to learn thoroughly the basic principles of the game.

Actively engaged in radio, you would think that he would have little time for outside activities, and yet this energetic and intelligent technician has found the time to become a member of the church bowling league, which, incidentally, he also founded. He's a choir member, member of the Lawn bowling team and chairman of the program committee for sports night in Springfield, Mass. Yes, Mr. Brown certainly leads an active, interesting and busy life.

In business for himself since 1923, he was Secre-
Page Twelve

tary of the Springfield Radio Service Organization for seven years and is a member in good standing of the Institute of Radio Engineers. In the same store since 1931, he has done servicing, maintenance and design work on radio receivers, phonographs, test equipment, amplifiers, call systems and electronic devices.

Primarily, Mr. Brown has been interested in selling technical service and makes no sales of radio receivers but does have the largest complete record stock in his city. After the war, to which we all look forward with great hopes, Brown believes that he will be able to build up the store and his record stock to twice the present size. His store hours are from 9:30 a.m. to 5:30 p.m. and he gives better than 36 hour service on any repair job. On the average, he tells us, there are about twenty jobs per day finished.

Tubes being scarce, these days, he finds solutions to tube problems in using adapters and says that he has found it unnecessary, except in the case of a small number of radios, to make extensive changes in wiring to accommodate substitute tubes. Instead, Mr. Brown makes frequent use of adapters which eliminate the cost to the customer of reconversion back to the original circuit when the tubes again become available.

Not the least interesting thing about Mr. Brown in his garden. It's quite big enough, 135 x 60, and is filled with every type of vegetable as well as some forty varieties of flowers. As soon as it

is cleared for winter, it becomes a playground for his children, two boys and a girl. Weather permitting, it is used as an outdoor skating rink, so that it is clear Mr. Brown uses intelligence not only in doing his radio work but equally in patterning his life wisely and usefully, giving happiness to others. Owing his home, he has done extensive remodeling to it and it is one of the show places of the vicinity.

In an article appearing in a recent issue of the popular Radio magazine, Radio and Television Retailing, the editor said of Mr. Brown, "Currently, Lyman Brown is specializing in fine radio repair, and uses adaptors as well as other methods of tube substitution. He also operates on a consultation basis with several of the war plants in the vicinity, doing installation and maintenance of sound systems. Liquid measuring devices, temperature controls, testing apparatus, call systems, amplifiers and carrier controls are also in his line. Consultation service is charged by the job, rather than on a blanket contract basis.

"Brown manufactures his own test equipment. Closes up shop evenings. Makes no deliveries or pickups."

The accomplishments of L. Lyman Brown are unique and unusual in a sense, but there is no reason why any other N.R.I. man, willing to work and study, should not do just as well. You can just bet that we get as much of a kick—almost—as the men themselves when they make good—because then we know that N.R.I. training not only is good but that it proves its worth in a very tangible and definite way, by helping you to secure the better things in life, which, after all, is the purpose of all labor and effort. That's why we take an interest in all students and why your problems are of interest not only from a technical angle but fully as well from a human viewpoint. We want you to succeed and we know that you can. But it's going to take effort. There is no royal and easy road. You've got to study and you've got to work, and if you will do that you can be sure of your success, you need not any longer merely wish for it. Remember that when the going gets tough and you feel that you might as well give up, just keep the N.R.I. diploma in mind, and work toward it and recognition as a trained radio man.

In business since 1923, Mr. Lyman Brown has been in the same store since 1931, doing service, repairs, maintenance, construction, consultation service on Radio receivers, phonographs, amplifiers, call systems, electronic devices, amplifier rentals.



This convenient and attractive record rack is used for displaying records in a way which stimulates interest and aids in sales.



A view of the store front of L. Lyman Brown, featuring the sale of records. An interesting store window layout is used to attract favorable attention.



Fig. 1—Soldier equipped with lip mike and hearing-aid type earphones.

A NEW type of microphone is the lip microphone. It makes use of the "differential" principle. That is, the mike is so designed that sound coming from a direction other than from the lips is picked up very inefficiently, permitting discrimination against unwanted sounds.

In a tank, an airplane cabin, or some other noisy place, a microphone of this type is very useful. A hand-held model of the differential microphone has been used successfully in combat by the Canadian Ground Forces for over a year. A standard microphone held close to the lips may give a 5 db. noise reduction measured at the output of the microphone.

The lip microphone, illustrated in Fig. 1, averages 20 db. noise reduction which means almost complete elimination of background noise. The microphone produces less than 10% total harmonic distortion at 1000 cycles. The frequency response, relatively flat from 200 to 4000 cycles, is sufficient for all speech transmission purposes. The microphone is complete with harness, cord and plug and weighs about 1¾ ounces, is 1¼ inches square, ¾ inch thick. The moulded bakelite case reduces the use of strategic materials and facilitates mass production.

Originally, the mike was designed to be worn like a pair of goggles, but wide variation in the

LIP MICROPHONES

position of ears made necessary the adoption of the present method, using a mounting plate which rests on the upper lip with bands to the ears. This construction permits the microphone to be worn under gas masks or dust respirators. Feather edges on the supporting strap prevent the possibility of disturbing the seal of a gas mask against the face in military applications.

The microphone was invented by F. Cheyney Beekley of the American Radio Relay League. The experimental work and development which followed was carried on by Louis Burroughs, Chief Engineer, and A. R. Kahn, both of Electro-Voice Manufacturing Company, South Bend, Indiana, in collaboration with H. C. Hornickel, Engineer, Fort Monmouth Signal Laboratory. Lt. Col. W. F. Soules, W91DCM, also was connected with the development work. The microphone is known as the T-45 and is now standard equipment for the Signal Corps Ground Forces. It is intended as a replacement of the throat microphone which gave relatively poor results and lacked intelligibility. The T-45 meets all requirements for rugged construction and has successfully withstood over 20,000 falls from a specified height. It is designed for operation under wide ranges of temperature from -40 to 185 degrees Fahrenheit. A specially developed synthetic rubber membrane 4/10,000 of an inch thick over the apertures protects the diaphragm and buttons from dust and moisture. The microphone withstands total immersion in water for ten minutes.

Telephone engineers have long recognized the need for a microphone which would reject noise or other unwanted sounds while providing normal response to the desired sound. There have been many acoustic approaches to the problem and many have found practical application. For use in telephone work, as an example, "mouth pieces" have been employed. An approach to the problem which proved extremely successful in the development of the T-45 was the use of the differential principle. In the microphone, both sides of a single diaphragm, or two complementary diaphragms, are so exposed as to make the microphone unresponsive to unwanted sounds such as noise but sensitive to desired sounds such as speech.

Referring to Fig. 2, the thickness of the microphone is small compared to the average wave length of the sound noise frequency signal. The noise cancellation effect depends amongst other things on the distance from one side of the diaphragm around the mike to the other side, because of the fact that sound wave lengths are considerably longer than this distance. The average noise encountered inside military equipment may well be above 115 db, (threshold of hearing or least intensity sound that you can hear is the 0 db. level) and a large portion of this noise lies in the 70 cycles per second vicinity, together with all other frequencies up to about 3000 cycles. Loud speech, measured $\frac{1}{4}$ inch from the lips, is approximately 114 db, above the threshold of hearing.

In Fig. 2, a single diaphragm is supported between two identical cavities which are completely enclosed in the plastic case of the microphone marked A. H is a holder or support. Each cavity has a small opening, J and K. These cavities are fitted with a moisture-sealing membrane, G and F, through which sound may enter. B, C, D and I form the usual carbon-microphone assembly of carbon granules, retaining fixed contact buttons and felt washers. The outer openings of the apertures are critically spaced. Sounds which enter both apertures, having equal intensity and identical phase, will not cause movement of the diaphragm because of the fact that sound pressures on both sides remain equal and out of phase--they cancel out. On the other hand, if there is a difference in either the amplitude or the phase between the sound waves or sound pressures entering the two apertures, the diaphragm will move. It depends on the "differential" or simply the difference between the sound pressures.

This differential action gives the microphone its ability to distinguish between sounds that are originating nearby and sounds that are originating at a distance. Naturally, speaking directly into the microphone, you have sound that is nearby and the noise signals produced by machinery in the vicinity of the microphone are at

a distance. This means discrimination between desired and undesired sounds, for a sound produced nearby produces a displacement or pressure against the diaphragm in such manner that there is more pressure on one side than on the other. The sound originating at a point somewhat distant from the lips and the microphone will produce equal pressures at the microphone. These pressures will balance out and that is the secret of noise elimination in the mike.

It is surprising that the differential principle was not reduced to workable form at an earlier date, since it was not entirely overlooked. A number of engineers thought of cancelling out un-

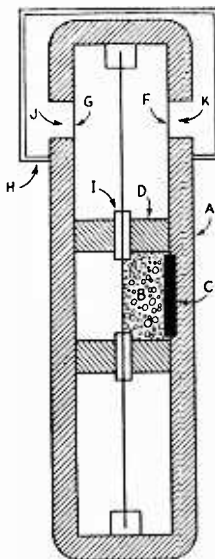

Fig. 2—Sketch showing the construction of the differential microphone. Details are discussed in the text.

wanted sounds by exposing them to both sides of a diaphragm. However, earlier work failed to attach sufficient importance to the relationships involved. The T-45 or lip microphone is primarily a war-time development designed to meet an urgent need for a microphone which would work in difficult locations, such as the inside of a tank. It is particularly interesting that amateurs, the radio experimenters of yesteryear, now engaged in war work, had a great deal to do with the development of this microphone. There seems to be no substitute for the radio amateurs' "know-how."

Oscillations, Squeals and Motorboating

By J. A. DOWIE

N.R.I. Chief Instructor



J. A. Dowie

A CERTAIN amount of feedback takes place in practically all radio tube stages. This feedback may be in phase with the input signal, causing regeneration, or out of phase, causing degeneration. The amount of feedback is one of the limiting factors in radio design. A certain amount helps to obtain desired characteristics. Regeneration increases the sensitivity, while degeneration in an audio amplifier increases the fidelity by flattening the response characteristics. However, if either kind of feedback gets out of hand, undesirable effects result. Excessive degeneration lowers gain, while excessive regeneration makes the receiver unstable.

As regeneration increases, the set becomes much more critical in its operation. Sensitivity and selectivity increase abnormally and the receiver response becomes very erratic. Small changes in humidity (affecting circuit Q slightly) will have such great effects on the response that the receiver will seldom act the same from day to day. When regeneration is carried too far, oscillation occurs. (There is so much feedback that the stage sustains oscillation by itself). Then radio reception is blocked entirely, or is accompanied by squeals, whistles, rushing noises, or motorboating sounds.

Before we learn how to localize oscillation, let us see just how feedback can occur.

Feedback Paths

Fig. 1 shows a typical i.f. amplifier stage. As in all radio stages, there is a certain amount of grid-plate capacity. This can act as a feedback path—even in modern pentode tubes, in which

the screen grid and the suppressor grid both tend to reduce this grid-plate capacity to a very small value. In addition, there is capacity coupling between grid and plate leads, as well as possible inductive coupling between the input and output tank circuits.

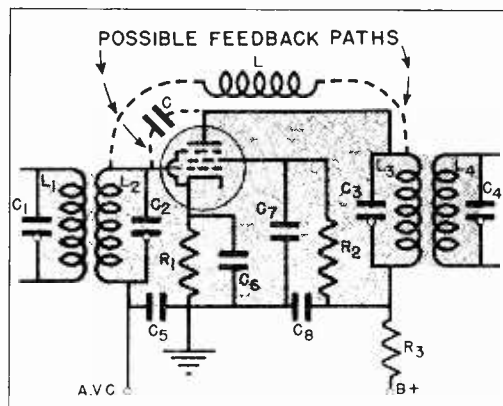

FIG. 1

Since it has a path for feedback and resonant grid and plate circuits, you can see that this circuit contains all the elements of a tuned plate oscillator. If the plate tank circuit is tuned so that the plate load is inductive (the tank circuit is tuned above resonance), then the

feedback will be in phase with the input signal, will aid it, and may cause oscillation.

Of course, oscillation will develop only if there is enough feedback. This will depend on both the amount of voltage in the plate circuit available for feedback, and upon the effect the feedback has in the grid circuit. If the stage has high gain, and if the plate tank circuit has a high Q factor (thus acting as a high-impedance load), there will of course be more voltage in the plate circuit available for feedback than if the stage had low gain or the tank circuit a low Q factor.

The Q factor is also important in the grid circuit; for the same amount of feedback, a grid circuit with a high Q factor will have more voltage across it than one with a low Q factor. (The reason is that the feedback capacity or inductance is in series with the grid impedance, forming our old friend, the voltage divider. The feedback voltage must divide between them; naturally, the higher the impedance of the grid circuit, the greater the percentage of the feedback voltage that will appear across it.)

Thus, problems caused by feedback will always be most frequent in high gain stages where tuning circuits of high Q are used. The more sensitive the receiver, the more you can expect oscillation troubles.

Incidentally, proper alignment may clear up oscillation in a circuit like that in Fig. 1. If the tank circuit C_1-L_1 is far off resonance, the reflected effects on C_2-L_2 are reduced, so the Q factor of the latter circuit will rise. Similarly, if tank circuit L_4-C_4 is far off resonance, the impedance of tank circuit C_3-L_3 will rise. Either condition may produce instability and oscillation. When the circuits are all correctly aligned, the reflected effects will load the tuned circuits in the offending stage and reduce their Q. Further, if the plate tank circuits are carefully tuned slightly below resonance (using an increased trimmer condenser capacity setting), then there is little chance for feedback to produce oscillation.

To sum up, oscillation can occur only if there is: 1. a feedback path; 2. feedback of the proper phase to aid oscillation (regeneration); and 3. the strength of the feedback is sufficient. Usually you will try to cure oscillation by blocking or removing the feedback path or by reducing the amount of feedback; changing the phase of feedback is not usually possible unless the feedback is caused by circuits whose alignment may be corrected.

Feedback Examples. Fig. 2 shows several more examples of circuits in which feedback can occur. In 2A the plate load is inductive (unless the reflected effects from the tuned circuit L_4-C_2

cancel all inductance in the plate circuit), so feedback from it will be in phase with the input signal and so may cause oscillation. In addition to the usual feedback paths, coupling may also exist between the tuned circuit L_4-C_2 and the antenna lead—especially if an excess length of antenna wire has been tacked into the radio. Feedback along this path may cause oscillation if it has the proper phase and is sufficiently large.

In an audio stage like that shown in Fig 2B, oscillation might occur but usually does not. The

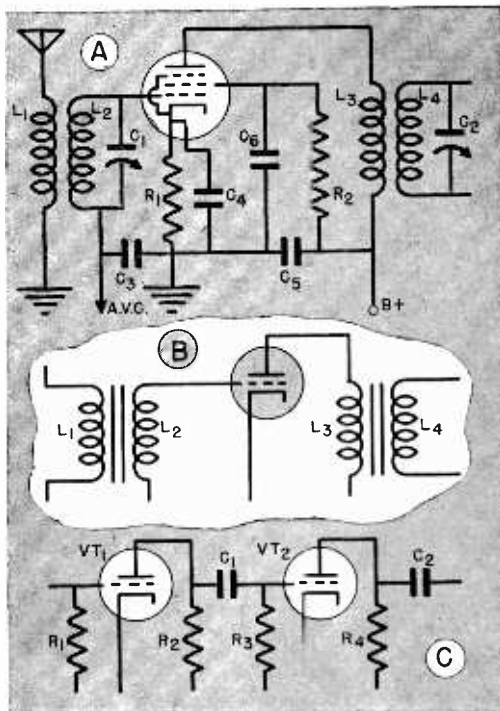

FIG. 2

effectiveness of the capacity coupling is relatively small, as the capacitive reactance of such small capacities is very high at audio frequencies, so most of the feedback energy is dropped in the coupling. In addition, the audio transformers usually have appreciable d.c. resistance. Thus, although they resonate with their distributed capacities, the Q is very low, so rather large feedback voltages are necessary to cause oscillation.

Of course, if another stage is added, the increased amplification makes it possible for the feedback voltage to be considerably higher; if

uses circuit elements which readily permit parasitic oscillations. This trouble is most common when the output stage is run as a class AB or class B push-pull amplifier, where a low-resistance input transformer must be used. A typical circuit is shown in Fig. 4.

The oscillation occurs at frequencies where the leakage inductance and distributed capacity of the transformers form resonant circuits, or where the transformer capacities remove the inductance effects, leaving the grid and plate leads to act as transmission lines due to their distributed inductance and capacity. The circuits act as tuned-grid tuned-plate oscillators which may produce oscillations well up in the short waves.

This parasitic oscillation does not occur in every circuit, of course. It may occur, however, in any circuit in which enough power is available, in which enough feedback exists, and in which the grid inductance and capacity can form a resonant circuit.

Parasitic oscillation causes severe distortion, weak reception, and perhaps a rushing noise or exceedingly high-frequency whistle. The large amount of power consumed lowers all operating voltages. The output tubes may glow blue or even get so hot their elements melt. The rectifier tube, filter choke, power transformer and output trans-

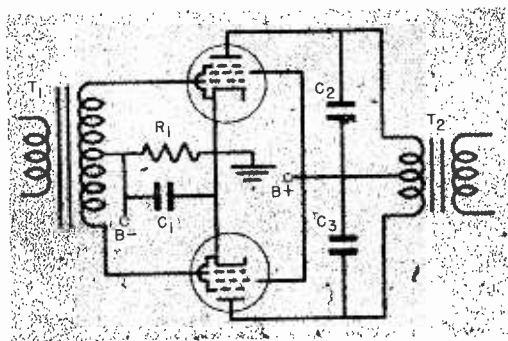

FIG. 4

former will be passing excessive current, so will overheat.

The condition may be cured either by introducing suppression, making the plate circuit bypass condenser more effective, or else by shortening the effective length of the grid leads so much that the tube will not be able to oscillate.

As you have learned, a low Q factor tends to suppress oscillation. Therefore, one of the most effective cures for parasitics is to insert suppressor resistors right at the grid terminals of each tube, as shown in Fig. 5. Resistors R_2 and R_3 should be between 100 and 1000 ohms. Use the smallest size which will eliminate oscillation.

In a class B output stage, grid current will cause distortion if values above 500 ohms are used. Hence, if larger suppressors are needed to stop oscillations, use about 200 ohms and consider the following procedures.

Manufacturers generally use condensers such as C_2 and C_3 of Fig. 4 in circuits where parasitics may develop, to make the plate load more capacitive. Such condensers should be right at the tube socket, a position which makes the effective length of the plate leads shorter, reducing further the inductance effects as well as the ability to feed back.

In the circuit shown in Fig. 4, the bypass paths from the plates run through condensers C_2 and C_3 to B+, from B+ to B- by way of the output

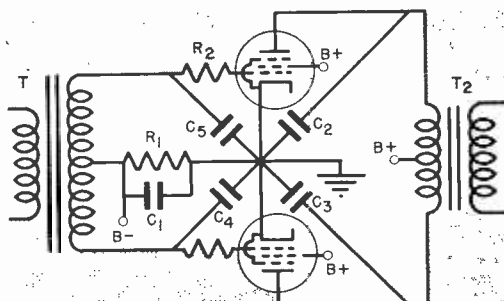

FIG. 5

filter condenser, and then to the cathode through condenser C_1 . Bringing C_2 and C_3 directly to the cathode, as shown in Fig. 5, eliminates a great deal of this path, and so makes parasitic oscillations less likely. If C_2 and C_3 are used in this manner, they must have voltage ratings of 600 volts or higher.

As an additional measure, grid condensers of about .0005 mfd. each can be installed to change the grid resonant frequency, as shown by C_4 and C_5 in Fig. 5. (Sometimes they are installed by the manufacturer.) If used, C_4 and C_5 should return to the same cathode point as C_2 and C_3 .

Remember that an electrolytic condenser makes

a very poor r.f. bypass condenser because its inductive winding limits its effectiveness at high frequencies. For this reason, a paper bypass condenser is connected across the output filter condenser in many receivers; sets without this feature frequently prove unstable. Never assume that an electrolytic condenser is an adequate bypass for all frequencies which may be present.

Effect-To-Cause Reasoning

As you have learned, oscillation may occur in a single stage of a radio receiver or may be the result of feedback across several stages. Your first problem is to localize the trouble, then you must cure it, generally by reducing the gain of the stage, by restoring bypass facilities to normal, or by blocking feedback paths.

Oscillations may be audible or inaudible, and may occur anywhere in the radio. *If the oscillations are audible, whether or not signals are tuned in, they are audio signals and in all probability originate in the audio amplifier.* The only usual exception occurs when an a.v.c. controlled stage is oscillating and blocking simultaneously—that is, the circuit starts to oscillate, but sufficient grid bias is developed (particularly across a.v.c. resistors) to block oscillation at an audio rate. Motorboating can be caused once in a while by this particular combination of conditions.

To tell whether a steadily produced whistle or "put-put" is in the audio system or in the last i.f. stage, turn the volume control to zero output. In most modern receivers the volume control is at the input of the audio amplifier. If a volume control adjustment will stop the sound coming from the speaker, then it is originating ahead of the control and is probably in the i.f. amplifier. On the other hand, the oscillation is probably originating in the audio amplifier if moving the control does not affect the oscillation.

In one peculiar condition where the feedback occurs to the grid circuit containing the volume control, varying the volume control will vary the amount of feedback and throw this particular circuit in and out of oscillation. If the set has a tuning indicator, notice whether the volume control adjustment stops its deflections as well as the sound output. If the tuning indicator continues to deflect with the volume control at zero, then oscillations are still occurring in some a.v.c.-controlled stage.

If no indicator is used, pull out the last i.f. tube. If this stops the sounds, the trouble is in the r.f. section; otherwise, an audio trouble is present.

If oscillations occur only when a station is tuned in, then they are undoubtedly starting in the r.f.

or i.f. stages. In a set with this trouble, you will notice a loud whistle or squeal as you tune in a station; then as you tune slowly through the proper dial setting, the squeal will first drop to zero frequency and then increase in pitch again on the other side of the correct dial point.

If the ability to oscillate appears greater at one end of the dial than the other, an r.f. stage is probably to blame. In this case, the variation is caused by the fact that different frequencies will vary the amount of feedback and may, because of differences in alignment, vary the input and output impedances of the offending stage.

Be careful in making this check for suspected oscillation not to confuse these noises with whistles due to oscillator harmonic interferences, second harmonics of the i.f. amplifier, and similar causes, which have been discussed elsewhere. These last interferences will show up only at certain particular spots on the dial or only on certain stations, rather than over the entire dial or a large portion of it.

Parasitic oscillations are not usually audible except as a sort of rushing noise. To help yourself diagnose them, remember that the great amount of power taken when these oscillations occur lowers the voltages throughout the receiver, so that weak or badly distorted reception, or possibly a dead receiver, may result.

Locating the Defective Stage

The most common sources of trouble are missing or poorly connected shielding, and defective condensers in supply circuits common to more than one stage. The condensers most likely to cause oscillation, arranged in order with the most common troubles first, are:

1. Open screen grid bypass.
2. Open or low-capacity output filter.
3. Open or low-capacity plate decoupler.
4. Open cathode bypass.
5. Open or shorted grid decoupler (a shorted one removes bias.)
6. Open bias supply bypass.

To make a quick check, first inspect the shielding visually, then tune in a signal and try a good bypass condenser across those listed in 1 and 2 above. If the oscillations continue, it is best to localize the defective stage.

A simple way to localize the trouble is to tune in a signal, and bring your hand near one tube at a time. As you approach the offending stage, you will change the pitch of the whistle or squeal.

If you have a signal tracer, use it on each stage

In turn (starting at the input and moving toward the output) with no signal tuned in. Since oscillations produce r.f. voltages, you will find an r.f. voltage present when you enter the defective stage. Sometimes this procedure will not work satisfactorily, because connecting the signal tracer or bringing your hand near the offending stage may stop it from oscillating. You will then probably pass over the offender, find the signal in the next stage, and believe that it is the defective one.

In the audio stages, you can test each stage with an audio signal tracer, starting at the input and moving toward the output. Here again, you may stop the oscillation when you connect the tracer.

The fact that your tests may stop the oscillation temporarily makes it rather difficult to do more than locate the defective stage with test equipment. If an open bypass condenser is suspected, you will have to hold a good condenser across each section you want to test. Remember, particularly when working with r.f. stages, that long leads cannot be used—you must hold the replacement condenser directly across the suspected one. Bend the test condenser leads so you can touch the proper points.

If the oscillation stops when you make such a condenser test, remember that it may do so because of the presence of your hand, not because of the condenser. If this happens, you will find it out quickly, because oscillation will usually start again as soon as you finish putting in the new condenser and remove your hand. It is usually a good idea to solder the trial condenser across the suspected one temporarily, then take your hands away to see if oscillation has stopped, before making a permanent replacement. This is a good servicing procedure.

You should, of course, check an oscillating set to make sure that all tube shields for which provisions are made are actually used. But don't assume that the shielding is satisfactory just because they are all present—remember, a poor contact between a shield and the chassis may make the shield ineffective. Try grounding such shields to the chassis with a short test lead or screwdriver blade. If this helps, sandpaper the edges of the shield and tighten the screws or rivets used to ground it. Since rivets sometimes corrode, replacing them with screws may prove helpful.

Oscillation in an r.f. stage may be caused by a poor contact to the tuning condenser rotor shaft if the resistance of the contact provides a common coupling between condenser sections. Be sure to clean and tighten wiping contacts if trouble is localized in this section of the set.

Remember that abnormal feedback must occur in the set to cause oscillation. To cure the condition, you must either block the feedback path or make circuit adjustments to cut down the amount of feedback. If you can find nothing out of the ordinary which could provide a feedback path, see if the stage has exceptional gain. Since this can easily be caused by higher-than-normal screen grid voltage or by lack of proper bias voltage, a short-circuited bias supply or an open screen bleeder may be the cause of the oscillation.

Misplaced wires are a frequent cause of oscillation. Always look for them if an oscillating set shows evidence of a previous repair. If you find that moving a wire causes a change in the pitch of the oscillation, move both this wire and its neighbors carefully until you find a position which will give minimum feedback.

The manufacturer's service information is frequently helpful in finding this position. In all sets in which regeneration is allowed to exist to a considerable degree—small a.c.-d.c. receivers, for example—misplaced leads can easily cause oscillation. The manufacturer of such sets will frequently give information on "lead dressing," that is, how to position leads with respect to each other and to the chassis to prevent oscillation.

This Manpower Shortage!



Drawn by Graduate Art Miller

"That's so I can tell when it overheats."

Page Twenty-One

News OF THE Radio World

BY W. R. MOODY

RCA Industrial Music Service has announced that after the war as many as 130,000 plants and factories may require industrial public address systems. Radio dealers and servicemen will be profitably busy installing and servicing the equipment.

According to a survey completed by F-M Broadcasters, manufacturers expect to produce around 20,000,000 frequency modulation receivers following the end of the war. In all, around \$10,000,000 may be spent post-war for new FM transmitters and facilities.

Among the first planes to arrive as the Air Forces take over an airfield captured by ground troops is a plane carrying a complete ground-to-plane radio outfit, including a sectional antenna mast of tubular plywood.

The two national political conventions, held at the Chicago Stadium, were covered by RKO Television Corporation for the National Broadcasting Company. The proceedings of both conventions were recorded on special television films which were shown daily from Chicago to New York and telecast to the television receivers in New York, Philadelphia and Schenectady through the facilities of WNBC, WPTZ and WRGB.

The radio industry produced 13,000,000 receivers in its peak year of 1941. This year the industry will have produced about \$3,000,000 worth of signal and communications equipment for the armed services.

Although New York State has the largest population of any state in the U. S., Mississippi has the greatest number of radios per home—almost $2\frac{1}{2}$ times the figure of New York. South Carolina is second highest.

Railroads are interested in radio apparatus for communications. Equipment which will permit contact between an engineer and a dispatcher or between an engineer and the caboose will probably be used in great quantities after the war. Some thirty applications are now before the Federal Communications Commission.

In the majority of railroad radiotelephone installations now in use, frequency-modulation equipment designed for operation at frequencies above 30 megacycles is employed. In many instances, notably on the railways systems of gov-

ernment-owned ordnance plants, operation has been conducted in the 30-40-megacycle band with output power ratings of locomotive transmitters ranging from 25 to 50 watts.

The consensus of manufacturing opinion on post-war Television seems to be that the cheapest direct-vision set (using a nine-inch diameter tube) will sell for \$150. The DeLuxe models will sell for up to \$1,200. Both table and console models are being planned. Antenna kits will be required.

In a message in the Zenith Radio Corporation House Organ, G. E. Gustafson, Vice-President in charge of engineering, says: "A waiting market for over six million combination radio sets (more than the total production of all radios in 1938) is eager to purchase radio combinations that will furnish the millions of new home planners and new home owners with a complete variety of entertainment and the best in music."

Due to the war, the production of quartz crystals has expanded in the United States to about 200 times its former output. This has resulted in heavy imports of the raw quartz from which they are made. The supply of this quartz for piezoelectric purposes comes principally from Brazil, where it is mined in open pits, entirely by hand labor. The quartz itself is a compound of silicon and oxygen, with a hardness scale rating of 7 as compared with a hardness rating of 10 for the diamond, and is found in varying shapes and sizes, some of it in beautiful apex formations.

At the present time there are 51 f-m stations operating on a commercial program basis and at least ten experimental and educational stations on the air. More than 50,000,000 people reside in the areas now served by f-m stations.

The new 50,000 ton U.S.S. Wisconsin has eight separate announcing systems, with twenty transmitters and 355 loudspeakers, and a telephone system with 950 handsets and 1,250 headsets, about three-quarters of these telephones being installed at battle stations.

A new commercial license has been granted to the Dumont Television Station in New York City. The station was formerly known as W2XWV and is now called WABD. The station's policy of furnishing time free of charge to advertising agencies and others for their experimental programs will not be changed.



N.R.I. ALUMNI NEWS

Louis J. Kunert	President
Peter J. Dunn	Vice-Pres.
Earl R. Bennett	Vice-Pres.
F. Earl Oliver	Vice-Pres.
Dr. Geo. B. Thompson	Vice-Pres.
Earl Merryman	Secretary
Louis L. Menne	Executive Secretary

NOMINEES FOR OFFICE DURING 1945

Charles J. Fehn of Philadelphia and Harry J. Stephens of Detroit are the nominees for President of the N.R.I. Alumni Association for 1945.

It was expected that Fehn would be nominated but Stephens is crashing into the national picture for the first time. A mighty good man is Harry Stephens. He has made a grand secretary for Detroit Chapter. A thoroughly competent business man who believes in efficiency and who is very exacting in practicing what he believes. Mr. Stephens has won the admiration of his Alumni friends in Detroit. His nomination for President is a real compliment to him.

Charley Fehn, of Philadelphia, of course, is a veteran in our Alumni Association. He has held just about every office in Philadelphia Chapter. When not in office he has been squarely behind the man occupying the chair. We have been fortunate, in all of our Chapters, to have a number of stalwarts to keep things moving, to help over the rough spots. Charley Fehn is such a fellow.

So there you have your ticket for President, in 1945, fellow Alumni brothers, Harry J. Stephens of Detroit and Charles J. Fehn of Philadelphia. Take your choice.

Eight candidates were nominated for Vice President. Four are to be elected. Those now in office who were re-nominated are Peter J. Dunn of Baltimore, Earl R. Bennett of Wilmette, Illinois, (a beautiful suburb of Chicago); F. Earl Oliver of Detroit, and Louis J. Kunert of New York, our retiring President who cannot be a candidate to succeed himself as President but who is eligible for the office of Vice President.

Ernest W. Gosnell of Baltimore is again a candidate. Gosnell is running a little stronger each year. J. J. Jenkins of Washington, D. C., is a candidate for Vice President this year. Jenkins was

a candidate for Secretary in 1941. Oliver B. Hill of Burbank, California, who was a candidate for Vice President two years ago, has bounced back again this year.

Allen B. Hartzell of Allentown, Pennsylvania, who was a candidate last year, is back again proving that he has some solid support.

Jenkins, Hill and Hartzell have no Chapter affiliations. It is a very healthy sign to have them nominated for office and we are sure they will do very well in the final balloting now being called for.

Earl A. Merryman was re-nominated for Secretary. That was no surprise. Earl polled more votes than all other candidates combined, for the office of Secretary, and his election is a certainty. It is nevertheless a real honor to Clyde Kiebach of Washington, D. C., to have been nominated to run against Mr. Merryman.

L. L. Menne also polled a heavy vote in being re-nominated for the office of Executive Secretary. Running against him is Mr. J. W. Gladden of Alexandria, Virginia, a first-time candidate and a swell fellow.

It will be interesting to our members to know that a considerable number of men were recognized in the balloting. The following received votes, although not enough to be nominated.

FOR PRESIDENT

- Peter J. Dunn, Baltimore, Md. (In service)
- C. S. Burkhart, Kansas City, Mo.
- Robert E. Many, Washington, D. C.
- James F. Barton, Greer, S. C.
- Harry Andresen, Chicago, Ill.
- J. Stanish, Detroit, Mich.
- J. J. Jenkins, Washington, D. C.
- Clyde D. Kiebach, Washington, D. C.
- Dr. Geo. B. Thompson, Los Angeles, Calif.

FOR VICE PRESIDENT

J. Stanish, Detroit, Mich.
Dr. Geo. B. Thompson, Los Angeles, Calif.
Arthur J. Haugen, Harmony, Minn.
Harry Andresen, Chicago, Ill.
Clarence Stokes, Philadelphia, Pa.
J. W. Meadwell, Saskatoon, Sask., Canada.
Chas. H. Shipman, E. Cleveland, Ohio.
John Stein, Union City, N. J.
H. F. Leeper, Canton, Ohio.
S. E. Banta, Gonzales, La.
John Jerry, Exeter, Calif.
John T. Dixon, St. John, N. B., Canada.
L. E. McAllister, Mt. Berry, Ga.
John E. Kreitner, Buffalo, N. Y.
J. A. Stegmaier, Arlington, N. J.
Joseph DuBois, Biddeford, Maine.
J. V. Williams, Bellingham, Wash.
L. H. Watkins, Ogden, Utah.
R. E. Sawyer, Vancouver, Wash.
R. E. Fullhart, Bartlesville, Okla.
A. C. Christensen, Sidney, Nebr.
Glen G. Garrett, Bonifay, Fla.
Byron Kiser, Fremont, Ohio.
Max J. Silvers, Raleigh, N. C.
Lowell Long, Geneva, Ind.
Earl Merryman, Washington, D. C.
L. L. Menne, Washington, D. C.
Irvin Gardner, Saratoga, N. C.
W. P. Brownlow, Johnson City, Tenn.
Wm. S. Nichols, Cynthiana, Ky.
Louis Crestin, Boston, Mass.
R. R. Wallace, Ben Hill, Ga.
Chas. W. Hardigree, Macon, Ga.
Chas. Fehn, Philadelphia, Pa.
H. A. Gilmore, Amarillo, Texas.
Raymond L. Drake, Cedar Falls, Iowa.
R. E. Many, Washington, D. C.
H. J. Rathbun, Sparta, Mo.
Wm. Dyson, Pawtucket, R. I.
G. C. Gunning, Smith's Falls, Ont., Canada.
Delbert Delaunoy, Weehawken, N. J.
T. E. Ellis, Richmond, Va.
P. Rochelle, Little Rock, Ark.
James Barton, Greer, S. C.
M. E. Perkins, Bristol, Conn.
Walter Leland, Orleans, Vt.
Arthur Miller, Cicero, Ill.
James Cada, Cicero, Ill.
J. W. Gladden, Alexandria, Va.
Harold Bailey, Peoria, Ill.
J. B. Gough, Baltimore, Md.
Samuel Robinson, Hagerstown, Md.
Claude W. Longstreet, Westfield, N. J.
Paul Howell, Rayville, La.
M. Martin, New Westminster, B. C., Canada.
Harold Chase, Detroit, Mich.
J. C. Duncan, Duncan, Wyo.
Alfred R. Guiles, Corinth, N. Y.
A. Campbell, St. Louis, Mo.
Arvil H. King, Montpelier, Idaho.
H. Bergerson, Sherbrooke, P. Q., Canada.
Robert Kirkman, Calgary, Alta., Canada.

Wm. G. Spathelf, Washington, D. C.
Charles W. Dussing, Syracuse, N. Y.
Wm. F. Speakman, Wilmington, Del.
Chase E. Brown, Indianapolis, Ind.
Austin L. Hatch, Ft. Lauderdale, Fla.
James E. Graham, Carlsbad, N. Mex.
O. A. Grendahl, Duluth, Minn.
J. I. Layman, Hector, Minn.
A. R. Stewart, Staples, Minn.
Jacob Knaak, Cleveland, Ohio.
Austin Vachone, Bath, Maine.
C. D. Parker, Lovelock, Nev.
Gorden E. DeRamus, Selma, Ala.
Ralph E. Locke, Calais, Maine.
Frederick Gaul, Freeland, Mich.
Arthur Cornellier, Dover, N. H.
J. E. Collins, Paris, Tenn.
Edgar E. Joiner, El Dorado, Ark.
Joseph Snyder, Danbury, Conn.
Louis Harrison, Ellis, Kans.
John C. Bills, Boise, Idaho.
C. S. Burkhart, Kansas City, Mo.
Harry Stephens, Detroit, Mich.
Don Smelley, Cotoandale, Ala.
Harvey Morris, Philadelphia, Pa.

FOR SECRETARY

Ralph Black, Grayridge, Mo.
Claude W. Longstreet, Westfield, N. J.
Earl R. Bennett, Evanston, Ill.
Robert Many, Washington, D. C.
John Jerry, Exeter, Calif.
Oliver B. Hill, Burbank, Calif.
John Stanish, Detroit, Mich.
F. Earl Oliver, Detroit, Mich.
J. J. Jenkins, Washington, D. C.
T. E. Ellis, Richmond, Va.
Robert Harrison, West Point, Miss.

FOR EXECUTIVE SECRETARY

Dr. Geo. B. Thompson, Los Angeles, Calif.
William Dyson, Pawtucket, R. I.
Irvin Gardner, Saratoga, N. C.
Peter Dunn, Baltimore, Md.
Louis A. Harrison, Ellis, Kans.
L. P. Ayres, Millsboro, Del.
Frederick Gaul, Freeland, Mich.
H. F. Leeper, Canton, Ohio.

All Alumni members are urged to vote. Please use ballot on right hand page. Mail it as early as possible.

The polls close December 30, 1944. All elected officers will serve for a term of one year. The results of this election will be announced in the next issue of the News. Mr. C. Alexander, bookkeeper at N.R.I., has again been appointed Teller to count the votes. Please mail your ballot to Mr. C. Alexander, Bookkeeper, National Radio Institute, 16th and U Sts. N. W., Washington 9, D. C.

New York Chapter

Here is a brief resume of our Chapter activities although it is difficult to give many of the details in a report of this kind. Men in this area should attend our meetings in order to fully appreciate what we are doing and the benefits which can be derived.

At the first meeting since our last report Mr. Pete Peterson started the meeting with a talk on radio servicing hints. This was followed by Mr. Schlette who spoke on volume controls. After a short recess Mr. Kendrick Barlow who has just come back into the fold after an absence of about five years, gave a nice talk on servicing automobile radios. Then came our service forum presided over by Robert Godas and Louis Pavan. Thirty-five were present at this meeting.

At our next regular meeting Pete Peterson again spoke to us this time on servicing problems he had encountered during the past weeks. Mr. P. Calabrese related some similar experiences after which Mr. Joel Robinson spoke to us on "Transformers at Work." Mr. Barlow again took up the subject of automobile radios and then Mr. Paul Ireland took over and answered questions following with our usual service forum. This was an exceedingly good meeting attended by thirty-six members.

The result of the work done by our program committee is reflected in our increased attendance. At the next regular meeting forty-nine were present. This included our four new members namely Mr. John A. Lomba, Mr. E. C. Ruocco, Mr. George F. Iversen and Mr. Louis Auteri. These men were given a very hearty welcome. Our officers are extremely proud of our increased attendance because it is an indication that the type of programs we are planning and preparing for our members are appreciated.

Mr. Pete Peterson again spoke to us at our next meeting giving us additional practical hints picked up during his servicing for the past several weeks. Mr. Frank Miale then gave us an excellent talk on radio tubes. Then followed our usual service forum again presided over by Mr. Robert Godas and Mr. Louis Pavan.

At regular intervals during the month our Executive Committee gets together for the purpose of planning the meetings. Thus we have a complete program for each meeting and lose no time in getting down to actual work.

Meetings are held on the first and third Thursday of each month at St. Mark's Community Center, 12 St. Mark's Place, New York City. If you neglect to attend our meetings you are missing something.

Frank Zimmer, Assistant Secretary.

Election Ballot

Fill in this ballot carefully, and mail it to National Headquarters immediately.

FOR PRESIDENT (Vote for one man)

- Charles J. Fehn, Philadelphia, Pa.
- Harry J. Stephens, Detroit, Mich.

FOR VICE PRESIDENT

(Vote for four men)

- Peter J. Dunn, Baltimore, Md.
- Earl R. Bennett, Evanston, Ill.
- F. Earl Oliver, Detroit, Mich.
- Louis J. Kunert, New York, N. Y.
- Ernest W. Gosnell, Baltimore, Md.
- Elmer E. Hartzell, Allentown, Penna.
- J. J. Jenkins, Washington, D. C.
- Oliver B. Hill, Burbank, Calif.

FOR SECRETARY (Vote for one man)

- Earl A. Merryman, Washington, D. C.
- Clyde Kiebach, Washington, D. C.

FOR EXECUTIVE SECRETARY

(Vote for one man)

- L. L. Menne, Washington, D. C.
- J. W. Gladden, Alexandria, Va.

SIGN HERE:

Your Name.....

Your Address.....

City..... State.....

Polls close December 30, 1944

Mail Your Completed Ballot to:

C. ALEXANDER, BOOKKEEPER
NATIONAL RADIO INSTITUTE
16th and U STREETS, N. W.
WASHINGTON 9, D. C.

Phila-Camden Chapter

We have started a series of lectures with demonstrations and they have proved extremely beneficial. Our members like them.

Norman Kraft and Harvey Morris have delivered the talks, for the most part, accompanied by blackboard drawings. Such subjects as "How to Locate Trouble in a Dead Receiver" are bound to draw a great deal of interest.

Chairman John McCaffrey also takes a hand in these talks. One of his talks was on the subject of "Resistors and How They Work."

William Little, one of our popular members, has moved to Miami, Florida, where he is in the radio business with his brother.

New members include Thomas Arnott, John Reger, Charles Rowe, Robert Meili, John Stewart and Chester Klader.



Phila-Camden Chapter picnic held on the spacious grounds of former Alumni President, Clarence W. Stokes, Neshaminy Falls, Penna.

Norman Kraft and Laverne Kulp continue to come down to our meetings from Perkasie, Penna., and John Dragan comes over from Trenton, N. J. This shows that distance means very little if meetings are interesting.

At a recent meeting, Harvey Morris conducted an interesting discussion on condensers. A number of condensers were brought to the meeting and they were then opened and passed around, so the members could see how they were made and their probable weak points.

One very interesting discussion came up regarding those cases where a condenser was neither shorted nor opened and yet would not work satisfactorily. Since in every case proper operation was obtained when the condenser was replaced,



The elbow-bending contest with Herman Doberstein, second from the right, taking a big lead.

it was fully apparent that the trouble was due to loss in capacity. This frequently occurs in electrolytic condensers, as the electrolyte starts to dry out. Also, the power factor of the condenser may increase, giving the same results.

You can quite easily check this condition by simply shunting the condenser you suspect with another of about the same capacity. If this clears up the trouble, the condenser under test has either lost capacity or developed a high power factor and should be replaced.

(Editor's Note: Never try to check a condenser you suspect of being shorted or leaky by shunting it with another. This short will still be there and you are not accomplishing anything. In this case, disconnect the condenser and check it with a ohmmeter or, if you wish, disconnect it and substitute another in its place. When working this way with electrolytics be sure to observe the polarity markings. Use a condenser with a working voltage at least as high as the original.)

Meetings are held on the first and third Thursday of the month in the Post Office Building, 4706 Comly Street, in Philadelphia.

James Sunday, Recording Secretary.





Executive Committee of New York Chapter. Rear row, left to right, Archie Burt, Paul Ireland and Frank Zimmer. Seated, Chairman Bert Wappler, Lou Kunert, and Pete Peterson.

Detroit Chapter

Following is a report of our activities since the last issue of the NEWS. Mr. Henry Rissi, a prominent radio and instrument serviceman, spoke to us on "Selling Service." And what a talk! It was chock full of very valuable information and held our members until 11:30 P.M. In spite of the late hour the meeting was followed with refreshments and our usual chummy get-together.

The next meeting was a particularly good one because we were favored with three motion pictures presented through the courtesy of the Michigan Bell Telephone Company. They showed the Company's use of radio in communications, especially in storm disasters. These motion pictures proved to be very interesting and also instructive.

Following the showing of the pictures our very able Earl Oliver took over and proceeded to service a radio explaining each step and giving his reasons for each operation as he went along. Oliver has a very complete radio shop in his home and has had long experience. He is one of several very competent radio men in our Chapter who are always glad to assist our less experienced members.

Ted Steinmetz is scheduled to give a talk on "Practical Use of Radio Laws." This talk is on the docket for our next meeting and will be reported in the next issue of the NEWS.

Our Chairman, Harold Chase, has opened a radio

service shop in Detroit, in partnership. The name for this new enterprise is CE Service and the location is 15731 Grand River. A big announcement of their grand opening laid emphasis on the fact that they specialize in "good as new" radio service. Harold Chase is a combination of good radioman and good businessman. He is bound to succeed.

Students as well as graduates are welcome to attend our meetings. If you live in the Detroit area and if you are not on the mailing list of Detroit Chapter, please send your name and address to the undersigned at 5910 Grayton Road, Detroit 24, Michigan. It will be a pleasure to send notices to you.

Harry R. Stephens, Secretary.

— n r i —

Chicago Chapter

Chicago Chapter has been meeting regularly. Our place of meeting is at 2759 South Crawford Avenue.

The Chapter has purchased some good used testing equipment. One instrument is an up-to-date tube tester and another is a signal generator. These instruments are owned by the Chapter for use by the Chapter members. Now we are equipped to do some real radio work at our meetings.

Our annual party is scheduled for Saturday evening, November 25. This will be in the form of a dance to be held at Lake View Post Hall, 3944 Lincoln Avenue. This issue of the NEWS will reach our members too late to be of any aid in notifying them regarding the annual dance but regular notices will be sent to all of our members in plenty of time.

Our Treasurer, Mr. Clark Adamson, went into Army service last spring. Mr. Richard Pierz was elected Treasurer to succeed Mr. Adamson. Mr. Pierz now has gone into the Navy and Mr. Steve Bognar therefore has been elected Treasurer to fill the unexpired term.

With our new equipment we will have better facilities for doing actual practical radio work. A new meeting place seems desirable and we hope to have some announcement on that before the end of the year. Therefore, all students and graduates in the Chicago territory who would like to attend our meetings are requested to send their name and address to the undersigned at 2306 West 51st Street, Chicago 9, Illinois so that they may be notified of meetings. All N.R.I. men will be assured a cordial welcome at our meetings.

Lloyd C. Immel, Secretary.

Baltimore Chapter

This chapter has come to a full realization that our members want more actual practical radio servicing work at our meetings, and want to devote less time to business matters. That is exactly the type of program we have on schedule.

Whatever business details are to be attended to are disposed of quickly. Mr. H. J. Rathbun then takes over, and from that time on we do nothing but actual radio servicing work, asking and answering questions as we go along.

Our members will soon be notified of the social affair being arranged by Chairman Gosnell at which time we'll celebrate the thirtieth anniversary of the National Radio Institute and the fifteenth anniversary of the N. R. I. Alumni Association. Pete Dunn, who was one of the first to take an active part in organizing Chapters in the N. R. I. Alumni Association and who is now in the Service, will also be remembered at this affair. Mr. Menne and Mr. Straughn will be present.

Meetings are held on the second and fourth Tuesday of each month at Red Men's Hall, 745 West Baltimore Street, in Baltimore. We shall be very glad to place you on our mailing list to receive notices of meetings. Send your name and address to E. W. Gosnell, 5222 St. Charles Ave.

L. Arthur, Secretary.



Janet, Grace and
Richard Snyder

This is a picture of the family of Harold J. Snyder of Baltimore, Md., little Janet, Mrs. Grace Snyder and the newest member, son Richard. Harold Snyder is doing a swell war job in Sunbury, Pennsylvania, but never loses contact with his Baltimore Chapter friends. We remember these fine young people when they were first married. They were regulars at Baltimore dances and socials. Lucky, Harold Snyder, and deserving of it all, too.

Page Thirty



A meeting of the New York Chapter.

— n r i —

The N.R.I. Tester



A student makes an interesting addition to the tester, housing it in a special cabinet.

N.R.I. student Eugene Fodor of New Brunswick, New Jersey, is an enterprising and intelligent student. As you can see in the accompanying photograph, Mr. Fodor has built a novel and worthwhile cabinet for his N.R.I. tester, which keeps it free of dirt and dust, thus enhancing the accuracy and reliability of the instrument. The experimental tester can be seen at the right.

— n r i —

To Lou Kunert, N.R.I. Alumni Association President, to Vice Presidents Pete Dunn, F. Earl Oliver, Dr. Geo. B. Thompson, and Earl R. Bennett, to Secretary Earl A. Merryman, to the officers of our local Chapters—thank you for your fine cooperation during the year just closing. May you continue to enjoy good health and may we see one another more frequently during 1945.

— n r i —

And to our ever loyal and faithful members—everywhere—a very Merry Christmas to all.

Lou Menne

Here And There Among Alumni Members

Harry Doyle of Uppertown, Quebec City, Canada, is employed by the Quebec Airways Observers, Ltd. (Empire Air Training) installing and servicing aircraft Radio equipment. Also does the daily inspection on the Radio equipment of 18 aircrafts and often more. Has been on forty-five Test Flights.

— n r i —

Alexander F. Johnson, of Dearborn, Mich., is employed in the Radio laboratory by Chrysler Engineering, Highland Park, Mich., finding ways to suppress trucks, tanks, marine and aircraft interference.

— n r i —

We understand John Dragon of Phila-Camden Chapter has been awarded a number of ribbons for weight lifting.

— n r i —

Leon R. Frisbee, of Eldred, Pa., says his wife felt she was a Radio widow while he concentrated on the study of his lessons but now that he has been a graduate for more than a year and money is rolling in as a result of his Radio work his wife is more than happy to feel she did her part to help him stick it out.

— n r i —

Mr. D. W. Barber is Chief Radio Operator, Chicago and Southern Airlines, New Orleans, La. He graduated in 1925. Had a nice letter from him recently. Nice to keep in touch with these old-timers.

— n r i —

Alfred J. Raper is a member of the Engineering staff at Station KJZ, Denver.

— n r i —

F. G. Fischer of Middle Lake, Sask., Canada, was married on October 1, we just learned. We understand Fischer has purchased a Motion Picture Theatre in Erickson, Man., Canada. He is also conducting a Radio shop from his new home. Fischer was formerly with graduate John W. Meadwell, who with Mrs. Meadwell, also an N.R.I. graduate, conducts the largest Radio repair shop in Saskatoon.

— n r i —

We are sorry to learn of the sudden death of Mrs. Lillian Kolb, mother of Mrs. Earl Oliver, of Detroit. Both Viola and Earl Oliver were very much devoted to Mrs. Kolb and we greatly sympathize with them.

— n r i —

That prince of fellows, George H. McDaniel, has gone up the middle aisle with the former Frances M. Hall. The McDaniels will make their home in Washington, D. C. Good luck to you, Mr. and Mrs. McDaniel.

— n r i —

Secretary Earl Merryman was home on furlough from his arduous duties in the Pacific. With his very pleasant wife he lunched with J. E. Smith and L. L. Menne and related some of his experiences. Earl has gone through plenty but was

looking ahead to his next secret assignment to do what he can to get the job over with. The few precious days Earl spent with Mrs. Merryman did much to boost his morale. Sweet couple.



— n r i —

Floyd A. Buehler, Librarian of Detroit Chapter until he joined the Navy, passed the Radio Tech. examination and was sent to school for a Pre-Radar course. A grand opportunity made possible by his N.R.I. foundation in Radio.

— n r i —

Received a very nice photo of the shop of Ralph R. Wolfe, of Wilkes-Barre, Pa. The shop is in his basement. He has been maintenance man for 25 years for a large department store. Now he also handles all service jobs on Capehart, R. C. A., Magnarox, Zenith, Philco and Emerson which they handle.

— n r i —

Speaking of photographs we also received one from George Ott, Jr., of Meadville, Pa. George is 24 years of age and has been an invalid for six years. Owing to an injury he is unable to walk. But you should see the swell test bench this chap has and the method he has developed for overcoming his physical handicap. Yes sir, George Ott, Jr., has what it takes—plenty of grit. Doing a good Radio business.

— n r i —

Wilfred LaPorte, of Pawtucket, R. I., is working for Walsh Kaiser Shipbuilding Division, installing, operating, testing and trouble-shooting on transmitters and receivers.

— n r i —

George W. Neel, of Hammond, Ind., has been repairing Radios since shortly after he started the N.R.I. Course and now has gone to the Ken-Rad Corp. in Owensboro, Ky., where he has a dandy connection.

— n r i —

Lloyd E. Knox, of Bellingham, Wash., was employed by graduate Phil Wiley and praises him highly as a grand fellow. But Knox had to ease up on account of poor health and now does only part time Radio work—a big help under the circumstances.

— n r i —

J. Audie McGraw, of Winnsboro, Ia., owns the Winnsboro Electric Service Shop and is doing very well.

— n r i —

Joseph Starr of Hamilton, Ont., Canada, took a job in the Meter and Relay department of Canadian Westinghouse while waiting for something in Radio with the company. After six months he was put in Radio Engineering—a good job at good pay and Joe Starr is entirely happy.



Raymond A. Heising

Raymond A. Heising, born on August 10, 1888, at Albert Lea, Minnesota, received the bachelor's degree in electrical engineering in 1912 from the University of North Dakota, and the master's degree in 1914 from the University of Wisconsin.

Since 1914 a member of the technical staff of the engineering department of the Western Electric Company, and its successor the Bell Telephone Laboratories, Mr. Heising developed and constructed the experimental transoceanic radiotelephone transmitter used at Arlington in 1915, and the constant current modulation system used almost exclusively in World War I radiotelephones and in early broadcast transmitters.

During World War I, he developed radiotelephone sets for the United States Army and Navy and educated in his laboratory men who became radio communication instructors in the Signal Corps. Since the bombing of Pearl Harbor by the Japs, he has continued research and development work in connection with ship-to-shore operation, short and long-wave transoceanic circuits, ultra-short waves, piezo-electric devices, and was awarded the Morris Liebmann Memorial Prize in 1921. He was President of the Institute of Radio Engineers in 1939.

Page Thirty-Two

NATIONAL



FROM N.R.I. TRAINING HEADQUARTERS

Vol. 11

December, 1944 - January, 1945

No. 6

Published every other month in the interest of the students and Alumni Association of the

NATIONAL RADIO INSTITUTE
Washington, D. C.

The Official Organ of the N. R. I. Alumni Association
Editorial and Business Office, 16th & You Sts., N. W.,
Washington, D. C.

L. L. MENNE, EDITOR

J. B. STRAUGHN, TECHNICAL EDITOR

NATIONAL RADIO NEWS accepts no paid advertising. Articles referring to products of manufacturers, wholesalers, etc., are included for readers' information only, and we assume no responsibility for these companies or their products.

Index

Article	Page
Tube Substitutions	3
N.R.I. Thirtieth Anniversary Luncheon	10
L. Lyman Brown, N.R.I. Graduate	12
Lip Microphones	14
Oscillations, Squeals and Motorboating	16
News of the Radio World	22
Data Sheet—Zenith, Models 5G500	23
Alumni Association Nominees	25
Election Ballot	27
Chapter News	28
Here and There Among Alumni Members	31